

Intelligent Door Lock System

HD5186-MF



Color Sample and Finishing :

SMART LOCK' S COLOR SAMPLE



▲ **BLACK** ▲ **SILVER** ▲ **GOLDEN**

▲ **Red Bronze** ▲ **GREEN Bronze**

[Http://www.honglg.com](http://www.honglg.com)

Lock product introduction for certification

Intertek

Intertek Legal Entity: Intertek Testing Services Shenzhen Ltd. Guangzhou Branch
Block E, No.7-2 Guang Gong Software Science Park, Cailin Road, Guangzhou Science City,
GETDD, Guangzhou, China
Telephone/Fax: 86-20-8213 9688/86-20-3285 7538

Test Verification of Conformity

On the basis of the tests undertaken, the sample(s) of the below product have been found to comply with the requirements of the referenced specifications at the time the tests were carried out.

Applicant Name & Address	: DONGGUAN SHIJIE HONGLG ELECTRONIC FACTORY 13-3 The First Industrial Park, Chong Huan West Road, Shijie town, Dongguan City, Guangdong, China									
Product(s) Tested	: Electronic lock									
Ratings and principal characteristics	: <table border="1" style="display: inline-table; border-collapse: collapse; text-align: center;"> <tr> <td style="width: 20px;">3</td> <td style="width: 20px;">S</td> <td style="width: 20px;">5</td> <td style="width: 20px;">0</td> <td style="width: 20px;">0</td> <td style="width: 20px;">J</td> <td style="width: 20px;">3</td> <td style="width: 20px;">1</td> <td style="width: 20px;">2</td> </tr> </table>	3	S	5	0	0	J	3	1	2
3	S	5	0	0	J	3	1	2		
Model(s)	: H1									
Brand name	: 宏力佳									
Relevant Standard(s)/Specification(s)	: EN14846:2008									
Verification Issuing Office Name & Address	: Same as Legal Entity									
Date of Test(s)	: August 5, 2013 to September 13, 2013									
Verification/Report Number(s)	: 130805059GZU-001 / 130805059-GZU-001									

NOTE: This verification is part of the full test report(s) and should be read in conjunction with it.

This Verification is for the exclusive use of Intertek's Client and is provided pursuant to the agreement between Intertek and its Client. Intertek's responsibility and liability are limited to the terms and conditions of the agreement. Intertek assumes no liability to any party, other than to the Client in accordance with the agreement, for any loss, expense or damage occasioned by the use of this Verification. Only the Client is authorized to copy or distribute this Verification. Any use of the Intertek name or one of its marks for the sale or advertisement of the tested material, product or service must first be approved in writing by Intertek. The observations and test results referenced from this Verification are relevant only to the sample tested. This Verification by itself does not imply that the material, product, or service is or has ever been under an Intertek certification program.



Signature

Name: Baud Qiu
Position: Senior Manager

Date: September 30, 2013

www.intertek.com
GFT-OP-11a (1-JUL-2012)



Contents Page(s)

I. Parts.....	5
II. Features.....	8
III. Specification	10
IV. Assortment	11
V. Installation.....	12
VI. Structure Diagram	14
VII. Wearing Parts.....	17
VIII. Packing List	19
IX. Accessories	20
X. Customer Opinion.....	22

I. Parts:

1. Panel : HD5186-MF



Description	Material	Finishing
Handle	304 stainless steel	PVD,drawing, satin
Panel	0.7 mm 304 stainless steel	PVD,drawing, satin
Battery Pack	Plastic	natural color with spray coloring

2. Lock mortise

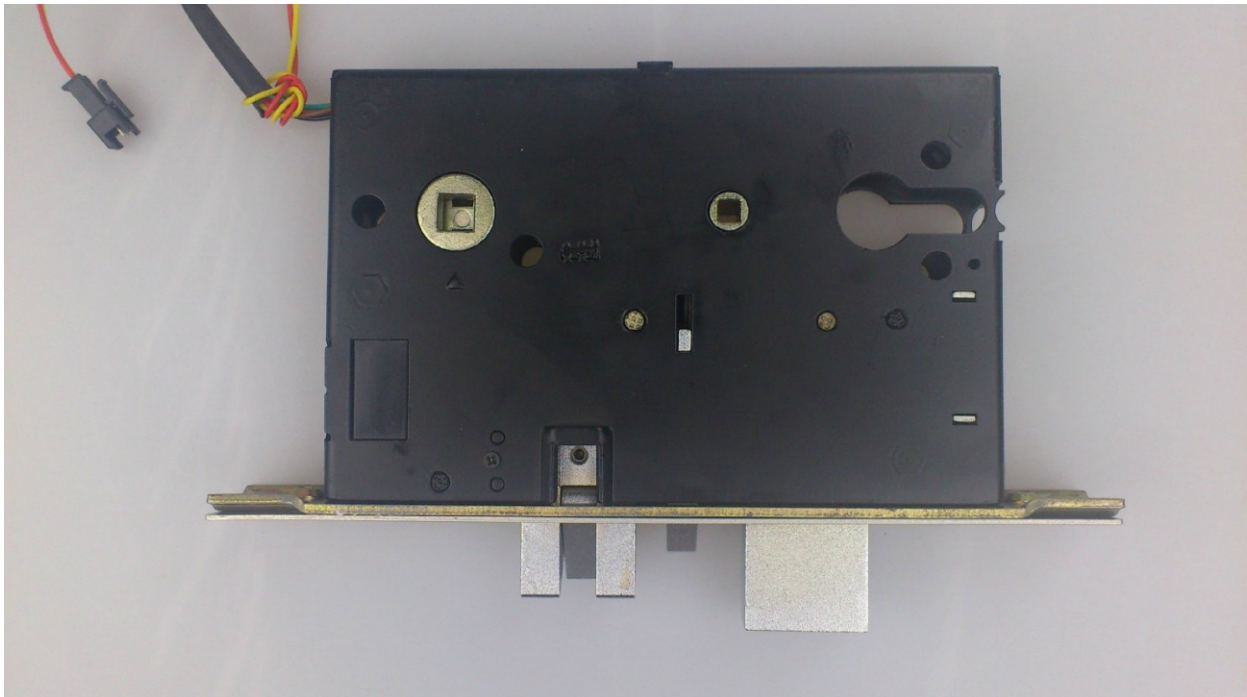

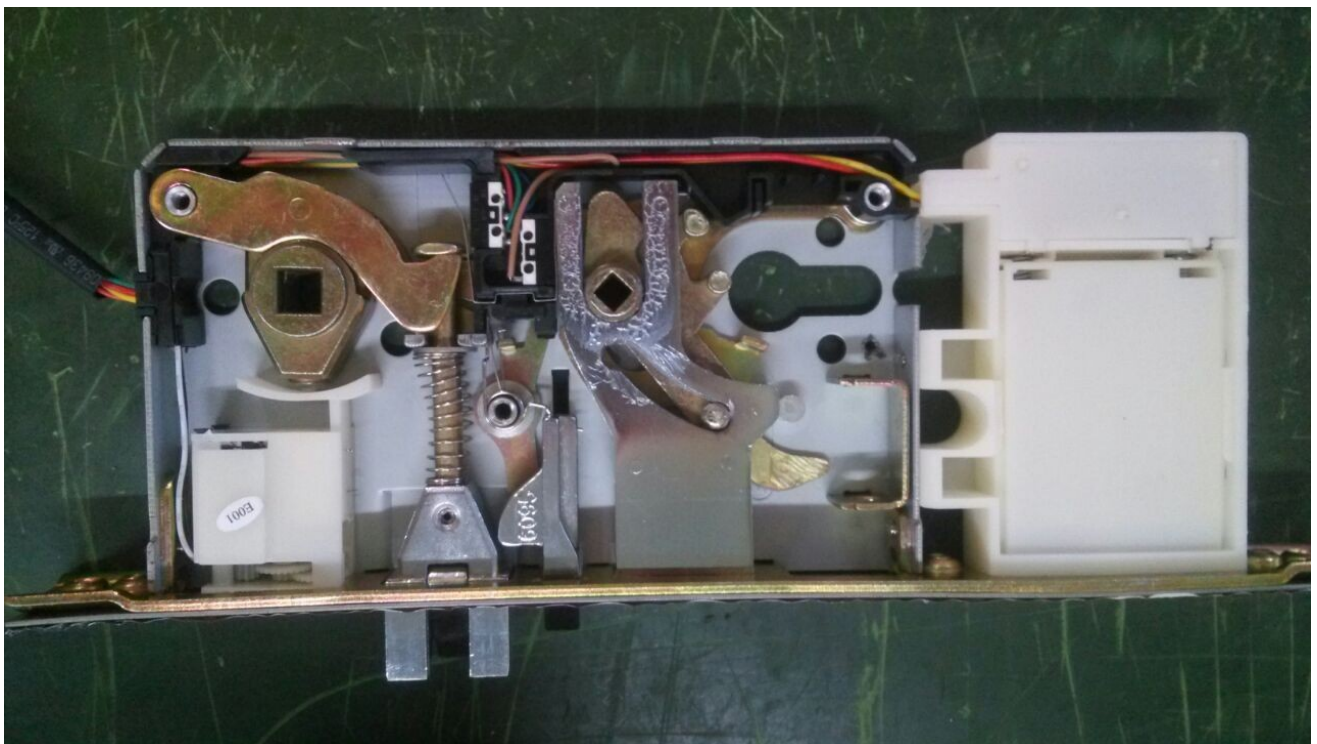

3. Strike Plate



II. Features

- 1. This Panel HD5186 compliant with temic and mifare one reader, the detail of each feature shall refer to manual.**
- 2. This HD5186 Panel are able to compliant with 04#,06#, 028# , 31# and KE handle.**
- 3. This lock mortise includes the battery pack and motor.**
- 4. Emit feature provide light and sound indication during the following condition: Lock setting; unlock; unable to unlock; low voltage; invalid card.**
- 5. Multiply lever management provide staff authority by the software program.**
- 6. Lock can be set in passage or privacy in necessary.**
- 7. Double lock feature to prevent staff or housekeeper to go into room.**
- 8. Audit trail feature provide the lock data; card unlock record; black list and mechanical key unlock record.**
- 9. Termination feature provide temporary card termination if guest of staff lost card.**
- 10. Advance card feature: Once new room cards are issued and show to door lock, the old or lost card are terminated immediately.**
- 11. Time Schedule: provide the restriction on staff to entry guest**



room after his duty schedule.

12. Common door and suite with inner room are provided.

13. Emergency open can used by key card and mechanical key.

14. Low voltage alert will emit in short light flashing and sound.

15. Unlock alert and break in alert alarm feature.

III. Specification

1. Raw Material on Panel

Panel's material is 0.7mm 304 stainless steel

2. Surface Finishing

PVD, drawing, Electro plating. Satin

3. Product Specification

Outside Panel: 288 mm(L)×78mm(W)×18mm(D);

Lock mortise: **centre distance 70*95mm**

Door Thickness: 38 ~ 60mm;

Net Wt.: 3140g; Gross Wt.: 3340g;

Packing: One lock in one package,8 package in a carton

4. Technical Specification

Low voltage alert 4.4 V ±0.2 V ;

Standby current: less than 30µA;

Operating current: less than 180mA;

Door response period: 5 second;

5. Operation Environment

Temperature: -20°C ~ 55°C;

Humidity: 20%~90%;

6. PCB Types

Various type of PCB can be installed on the lock such as temic and Mifare1.

7. Smart Keys

All locks comes with master mechanical key, Key alike provide with special order.

IV. Assortment

This HD5013 RF Panel are able to use the following type of temic card and mifare 1 card. Each of the detail is below listed:

Model No.	PCB #	Software	Accessories
HD 5186 - MF	Temic V8.0	ASHM Temic V8.0	Encoder TR-11U
HD 5186 - MF	MFV8.0	ASHM MFV8.0	Encoder MR-11U
HD 5186 - MF	MFV8.6	ASHM MFV8.6	Encoder MR-11U
HD 5186 - MF	MFV8.6	ASHM MFV8.6	Encoder MR-11U

V. Remark: Update of software will be available from the vendor only

V. Installation

1. Instruction

We have to ensure that the technician or worker must be familiar with the installation requirement in order to maintain a good performance on the lock. As refer to the below mentioned diagram Fig 1. The direction of lock shall be choose correctly with order. In case of necessary, the direction of handle must be only changed by trained technical on site.

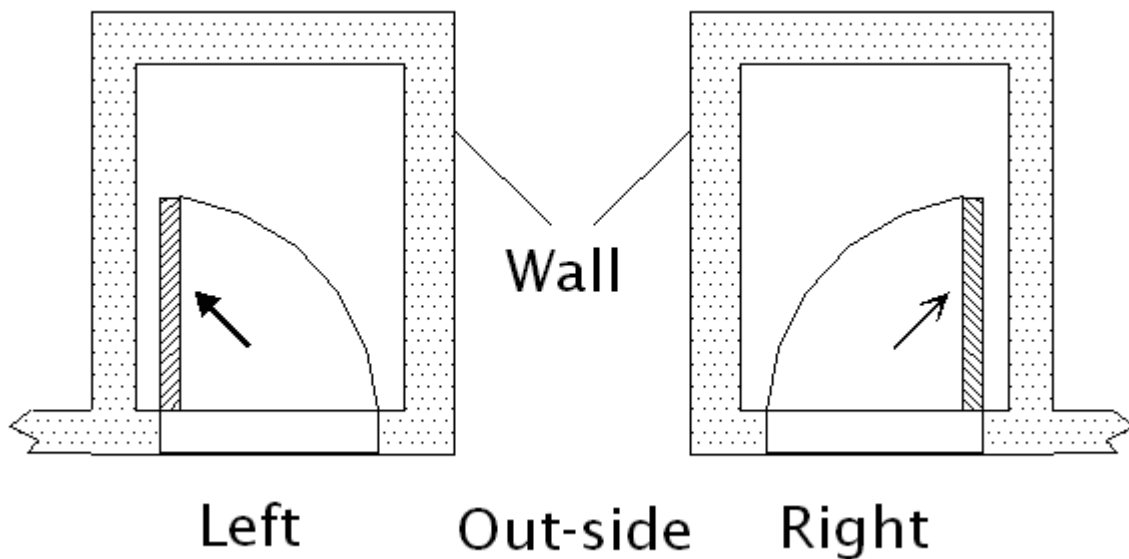
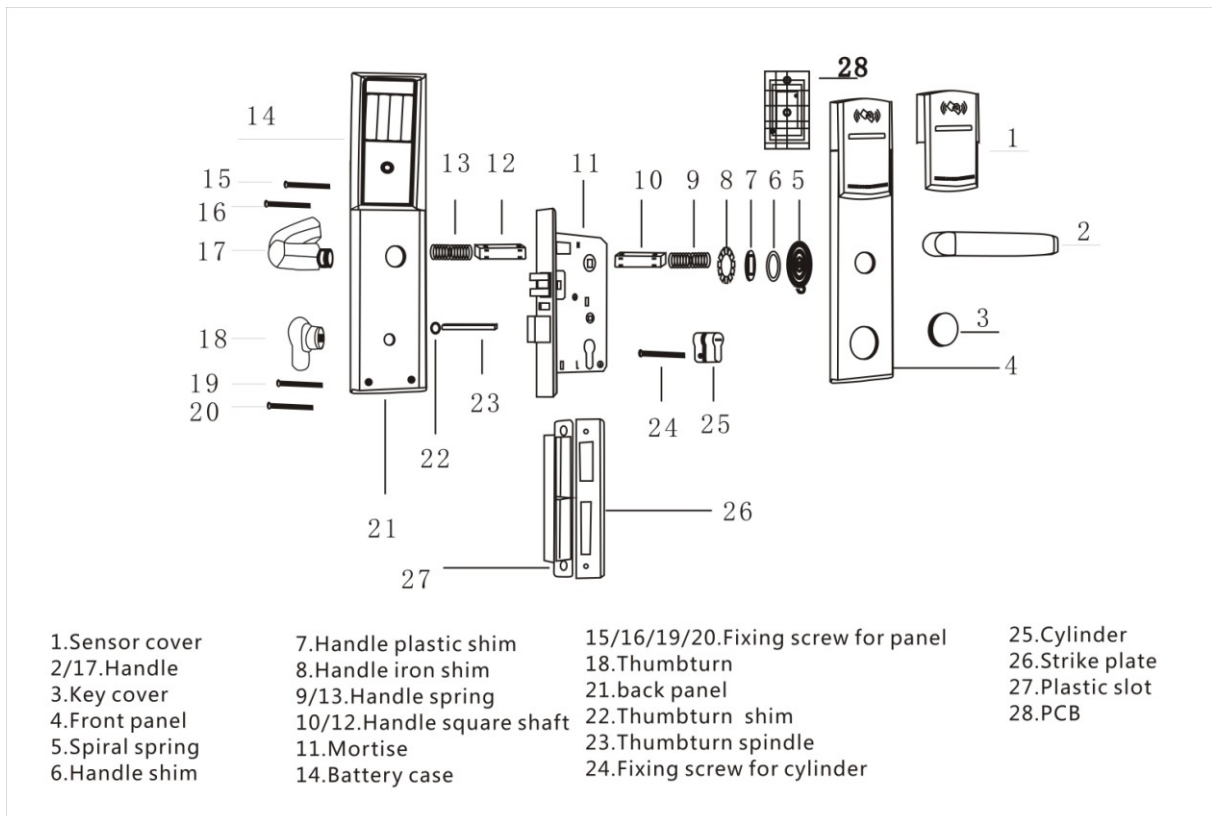

Figure 1

The lock can be installed to the wooden door with thickness between 38 – 60 mm, metal door need to confirm with the door manufacturer. The installation procedure shall be referred to the template.

Installation:



Maintenance:

1.1. Surfacing Finishing

The surface of lock must be cleaned regularly with appropriated cleaner and soft cloth, it is not recommended to use alcohol; water or chemical solvent to clean the lock, since it may rust the lock.

1.2. Grease

If the lock does not function smoothly, please ask qualified technician to add appropriate grease to the lock.

1.3. Changing Batteries

While changing the batteries, please remove the gap of the battery box and change the batteries. Only need to set the time for the lock again, for adjust the time.

VI. Structure Diagram

Outside View of Front Panel of HD 5186 - MF

↑
↑

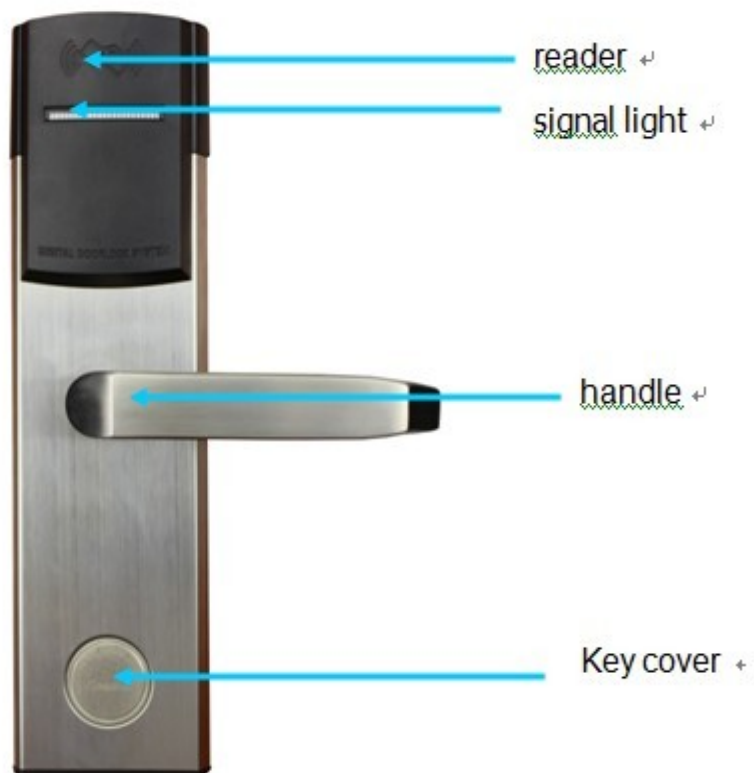

Inside View of Front Panel of HD 5186 - MF

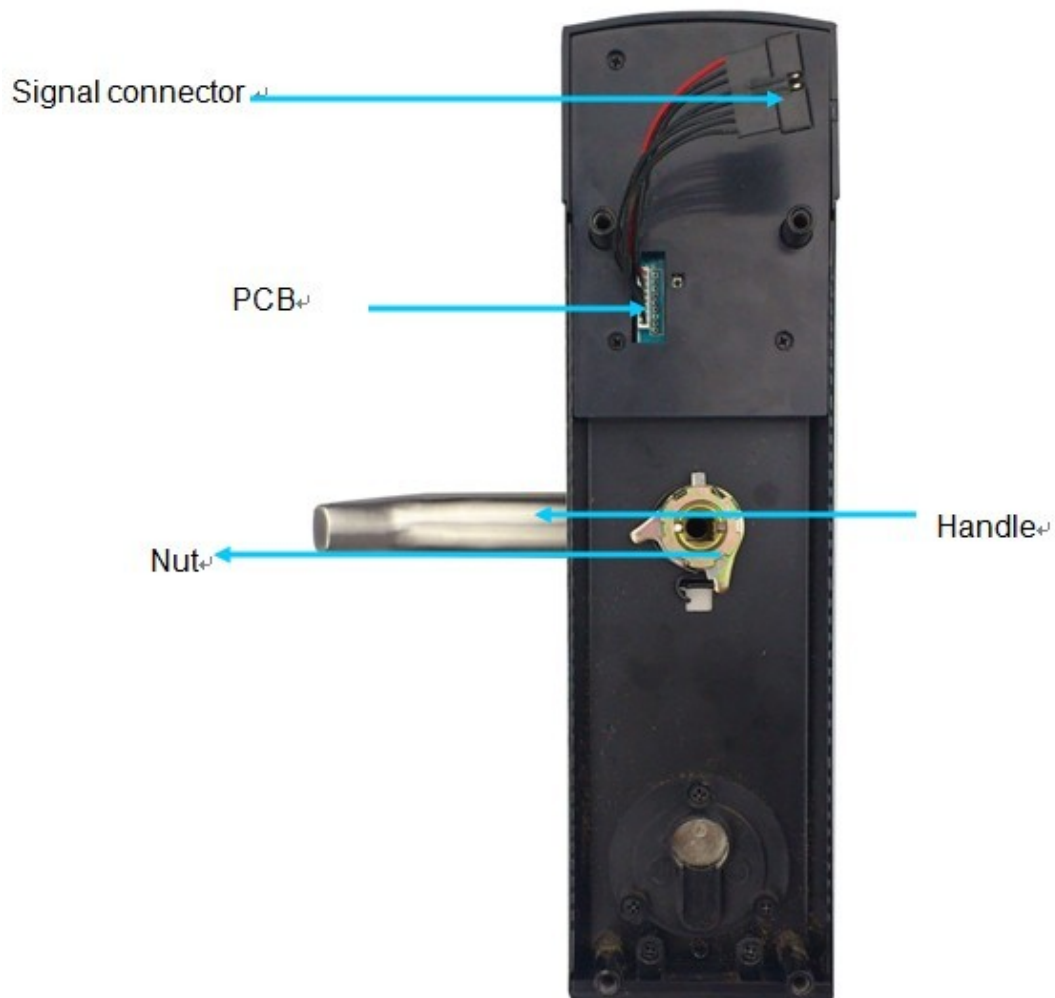

Mortise

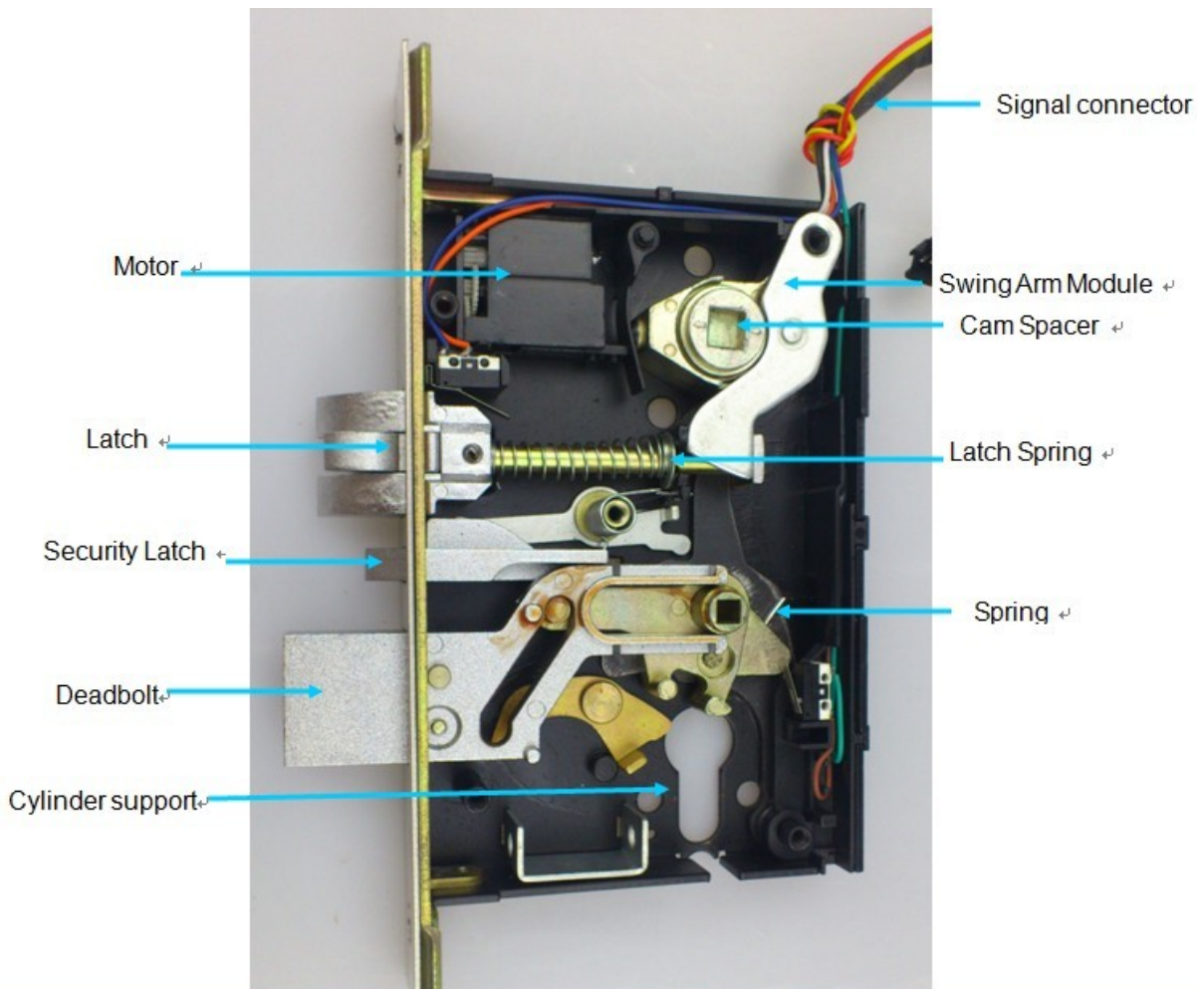

VII. Wearing Parts







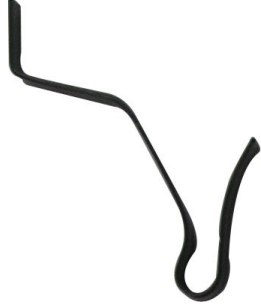















Fig.				
Des.	Key Cover	Flexible O ring	Lever Spring(L)	Lever Spring(R)
Nr.	HLG-C01	HLG-R01	HLG-S01	HLG-S02
Fig.				
Des.	O Ring	Lever Fitting	Card	Stress Spring
Nr.	HLG-R02	HLG-F01	HLG-C01	HLG-S03
Fig.				
Des.	Square Shaft	Shaft Spring	Battery Case	Motor Assembly
Nr.	HLG-SA01	HLG-SF01	HLG-B01	HLG-M01

Fig.				
Des.	Screw1	Screw2	Screw3	Screw4
Nr.	HLG-SW1	HLG-SW2	HLG-SW3	HLG-SW4
Fig.				
Des.	Lever Fixed Ring	Lever Fixed Cam	Nut	Cylinder
Nr.	HLG-FR01	HLG-FC01	HLG-Nu01	HLG-CY01
Fig.				
Des.	Pentagon Flat Screw	Hair Spring	Hair Spring for Security Latch	Line Ring
Nr.	HLG-FS01	HLG-HF01	HLG-HF02	HLG-LR01

VIII. Packing List

Item	Description	Figure	Qty.	Remarks
1	Outside Panel		1	The Pentagon screw used for the hotel lock, standalone lock use Philip screw. Self tapping screw normally uses with the standard of #GB/T 14210-93.3.
2	Inside Panel		1	
3	#9 Lock Case	5S1-01-00/4	1	
4	Strike Box	5S1-01-23	1	
5	Strike Plate	5S1-01-22/z	1	
6	8×8×44 Axle		2	
7	Spring for Axle		2	
8	5×5×65 Double Lock Shaft	2083-A-19	1	
9	M5×40 Pentagon Screw		2	
10	4.2×25 Self Tapping Screw		4	
11	Mechanical Key		3	
12	120×90 Seal Bag		1	
13	Key Cover	2083-10	1	
14	Installation Manual		Order	
15	Instruction Manual		Order	

Remark:

HD 5186 - RF contains the same packaging list on each lock except the reader on outside panel will be different version.

IX. Accessories

1. Temic Hotel Lock

Item	Descriptions	Unit	Qty.	Remark
1	HD 5186 - RF -SN/SB	pc	order	Finishing in Brushed stainless steel
2	Software	set	1	ASHM lock system
3	Temic Encoder(TR-11U)	pc	1	USB port
4	<u>T5557</u> Card	pc	order	For System card / Parameter card / clock card / meeting card / inhibit card / Guest/ Temporary/ Checkout / Terminating Card etc
5	<u>Data collector</u>	pc	1	Read access data of lock, store 500 records

2. Mifare one Hotel Lock

Item	Descriptions	Unit	Qty.	Remark
1	HD 5186 - MF -SN/SB	pc	order	Finishing in Brushed stainless steel
2	Software	set	1	ASHM lock system
3	Mifare Encoder(MR-11U)	pc	1	USB port
4	Mifare1 S50 Card	pc	order	For System card / Parameter card / clock card / meeting card / inhibit card / Guest/ Temporary/ Checkout / Terminating Card etc
5	Mifare1 S70 Card	pc	order	For Authorizing / Query Card store 1000 records.



Customer Opinion

Dear Client:

Good day to you and hope we have a good business together.

Thank you for choosing our products, the above are the product introduction for our Model HD 5186 series, should you have further inquiry, please feel free to contact us.

Sincerely.

Mohamed Shiekh Debs

Opinion: _____
